

 Salone
del Mobile.
Milano

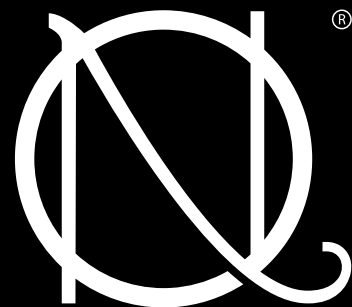

NICOLAQUINTO

— I T A L I A —

LISTINO PREZZI

PRICE LIST

www.nicolaquinto.com

NICOLA QUINTO
ITALIA

NICOLA QUINTO
ITALIA

E27

NICOLA QUINTO
ITALIA



NICOLA QUINTO
ITALIA

NICOLA QUINTO
ITALIA



NICOLA QUINTO
ITALIA



Salone
del Mobile.
Milano

È la cura di ogni dettaglio che fa la differenza e che permette di creare qualcosa di unico.

La NicolaQuinto offre un'ampia, eterogenea e versatile collezione. Comune elemento distintivo, simbolo di un'identificazione stilistica, è il prezioso ciondolo NQ.

It is the attention to every detail that makes the difference and allows you to create something unique.

NicolaQuinto offers a wide, diverse and versatile collection. Common distinguishing element, a symbol of stylistic identification, is the precious NQ pendant.



DIVERTITI A PERSONALIZZARE IL TUO DIVANO!
HAVE FUN CUSTOMIZING YOUR SOFA!

Il **ciondolo**, così come i **bottoni** NicolaQuinto sono disponibili nelle quattro versioni **Argento, Oro, Oro Rosa e Canna di Fucile**.

The pendant, as well as the Nicolaquinto buttons are available in the four versions Silver, Gold, Rose Gold and Gunmetal.



GUIDA ALLA LETTURA DEL LISTINO

LIST READING GUIDE

01.
 - I prezzi si intendono IVA esclusa, EXW;
 - *Prices are exclusive of VAT, EXW;*
02.
 - Gli optional hanno i relativi prezzi indicati in scheda.
 - *Optional items have their corresponding prices listed on the card.*
03.
 - Sono previste 3 categorie principali di rivestimenti, a loro volta suddivise in sottocategorie in base alla pregiatezza del rivestimento:
 - *There are 3 main categories of coatings, which are in turn divided into sub-categories according to the preciousness of the coating;*



Pelle Royal: categoria base che comprende Spessorata e Madras.

Pelle Premium: categoria media che comprende pelli Mezzofiore e Primofiore.

Pelle Luxury: categoria di alta qualità che comprende pelli speciali.

Royal leather: basic category that includes Thickened and Madras.

Premium leather: medium category that includes Mezzofiore and Primofiore leathers.

Luxury leather: high quality category that includes special leathers.

Tante tipologie di tessuto con numerose varianti di colore. Antimacchia, antigraffio e idrorepellente.

Many types of fabric with many color variations. Stain-resistant, scratch-resistant and water-repellent.

Collezione 2022 NicolaQuinto composta da un'accurata selezione di tessuti di esclusiva alta qualità italiana, lavorate secondo tradizione su telaio industriale.

Collection 2022 NicolaQuinto composed of a careful selection of exclusive high quality Italian fabrics, processed according to tradition on an industrial loom.



PREZZI ESEMPIO | PRICE EXAMPLE

MOD. RHAPSODY EXPO FIERA

Versione | version: 3 Posti Extra | 3 Seaters Extra

Rivestimento | Covering: NQ-AA-912 ASTRA CHANEL (MM A) +
NQ-DU-81 DUBAI Fucsia (Fabric C) + dettagli NQ-RI-13 RICCILOLO PANNA (MM C)

Prezzo Listino | Price List: : FABRIC C 2.336 EURO

*Cuscini accessori e poggiareni esclusi | *Cushions and backrest cushions excluded

NB: Il bordino è un elemento da non considerare nella valutazione del prezzo.
NB: Edging is an item not to be considered in the price evaluation.



Salone del Mobile. Milano

MODELLO RHAPSODY

NICOLAQUINTO®
ITALIA

Salone
del Mobile.
Milano



Rhapsody sale in passerella e viene presentato in anteprima al Salone del Mobile 2022 a Milano. Un divano che unisce il mondo della moda, da cui trae ispirazione e il mondo del mobile imbottito nel quale nasce. L'ampia seduta è un omaggio all'essenziale, alla purezza e grazie alle diverse densità dell'imbottitura dona un comfort unico. Il cordino in evidenza, i tagli trasversali sugli spigoli e le pieghe del rivestimento sul bracciolo sono chiari riferimenti al mondo dell'haute couture che conferiscono un'anima fashion e rock al divano.

Rhapsody takes the catwalk and is premiered at the Salone del Mobile 2022 in Milan. A sofa that combines the world of fashion, from which it draws inspiration, and the world of upholstered furniture in which it was born. The wide seat is a tribute to the essential, to purity, and thanks to the different densities of the padding it gives unique comfort. The prominent cord, the cross cuts on the edges and the folds of the upholstery on the armrest are clear references to the world of haute couture that give a fashion and rock soul to the sofa.

MODELLO RHAPSODY



DATI TECNICI

Struttura: multistrato, abete, faggio
Poggiatesta: poliuretano densità 30 kg/m³
Spalliera: poliuretano densità 30 kg/m³
Braccioli: poliuretano densità 30 kg/m³
Seduta: poliuretano densità 35 kg/m³
Piedi: acciaio lucido, canna di fucile, golden*

TECHNICAL DATA

Frame: plywood, fir, beech
Headrest: polyurethane density 30 kg/m³
Backrest: polyurethane density 30 kg/m³
Armrests: polyurethane density 30 kg/m³
Seat: polyurethane density 35 kg/m³
Feet: Shined metal, Gun Metal, Golden*

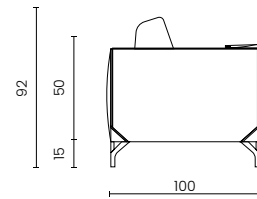

POLTRONA
harmchair

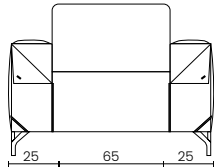

2 POSTI
2 seater

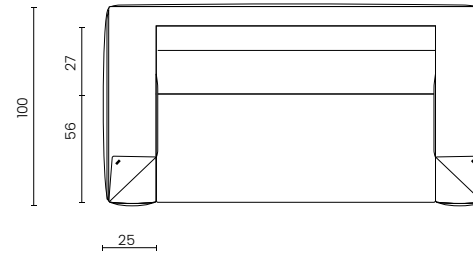
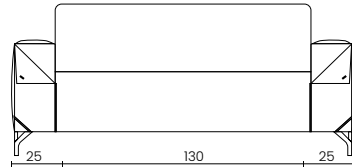

2 POSTI MAX
2 seater max

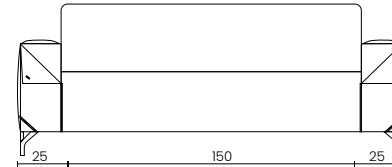

3 POSTI EXTRA
3 seater extra



LISTINO | PRICE LIST

RHAPSODY	VERSION	PESO	CBM	LEATHER					FABRIC			MODAMILANO				GREEN	
				LUXURY	PREMIUM C	PREMIUM B	PREMIUM A	ROYAL B	ROYAL A	FABRIC C	FABRIC B	FABRIC A	MM D	MM C	MM B		MM A
	3 SEATERS EXTRA	84	2,21	3832	3375	3222	3070	2714	2511	2336	2228	2119	3208	2845	2482	2264	3534
	2 SEATERS MAXI	70	1,84	3408	2993	2854	2715	2392	2207	2049	1950	1851	2841	2511	2181	1983	3138
	2 SEATERS	63	1,66	3012	2638	2514	2389	2098	1931	1789	1700	1611	2271	2205	1908	1730	2769
	ARMCHAIR	40	1,06	2149	1900	1816	1733	1539	1428	1333	1274	1215	1809	1610	1413	1294	1987

*PIEDI GOLDEN - FEET GOLDEN: 72 €

Nei casi di versioni componibili, richiesti con rifinitura nel rivestimento scelto anziché con fodera come normalmente prodotto, verrà valutato un sovrapprezzo concordato con l'azienda. Si precisa che per esigenze di produzione ci potrebbero essere modifiche nei materiali, nei rivestimenti e nelle dimensioni del prodotto senza preavviso. I pesi ed i volumi riportati in scheda sono prettamente indicativi poiché suscettibili di tolleranze dettate dai processi produttivi. Nelle realizzazioni combinate in diversi rivestimenti, in presenza di categorie differenti, il prezzo da considerare è quello della categoria più alta.

In cases of modular versions, requested with finishing in the chosen upholstery instead of lining as normally produced, a surcharge agreed with the company will be considered. It should be noted that due to production requirements there may be changes in materials, upholstery and product dimensions without prior notice. The weights and volumes given in the sheet are purely indicative as they are susceptible to tolerances dictated by production processes. In combined realizations in different coatings, where there are different categories, the price to be considered is that of the highest category.



PREZZI ESEMPIO | PRICE EXAMPLE

MOD. VANNA EXPO FIERA

Versione | version: 2 Posti 1 Bracciolo + Angolo + Poltrona Terminale Max | 2 Seaters 1 Arm + Angle + Terminal Armchair Max

Rivestimento | Covering: NQ-9603 PREMIUM Premium Cognac (Premium C) & NQ-MG-600 MAGENTO BIANCO (MM A)

Prezzo Listino | Price List: : LEATHER PREMIUM C 7.215 EURO

*Cuscini accessori e poggiatesta esclusi | *Cushions and backrest cushions excluded



Salone del Mobile. Milano



CARATTERISTICHE PRINCIPALI

- ✓ COMPONIBILE
- ✓ CUSCINATURA REMOVIBILE
- ✓ CUSCINATURA SFODERABILE
- ✓ POGGIATESTA
- ✓ PIEDI ALTI
- ✓ TAVOLINO

MAIN FEATURES

- ✓ MODULAR
- ✓ REMOVABLE CUSHIONING
- ✓ REMOVABLE CUSHIONING
- ✓ HEADREST
- ✓ HIGH FEET
- ✓ COFFEE TABLE



VANNA rappresenta una soluzione esclusiva per arredare il nostro living. Le sue forme morbide ed essenziali rappresentano il massimo della raffinatezza e sono definite con stile dalla struttura che abbraccia totalmente la cuscineria. Il bordino a rilievo che accompagnerà tutto il perimetro della struttura ed i piedi in metallo doneranno una sensazione di equilibrio tra struttura esile e ampia cuscineria.

VANNA represents an exclusive solution for furnishing our living room. Its soft and essential forms represent the ultimate in refinement and are stylishly defined by the structure that totally embraces the cushioning. The raised beading that will accompany the entire perimeter of the structure and the metal feet will give a feeling of balance between slender structure and wide cushioning.

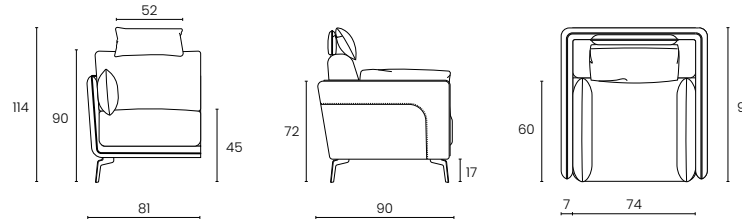

POLTRONA TERM
Terminal Armchair

POLTRONA MAX TERM
Terminal Armchair Max

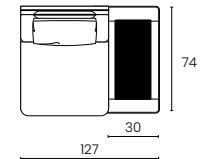
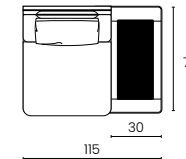

POGGIATESTA
Headrest

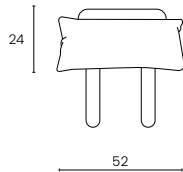

POLTRONA 1 BR
Armchair 1 arm

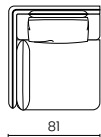

POLTRONA NO BR
Armchair no arm

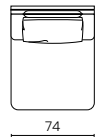

POLTRONA MAX
Armchair max



POLTRONA MAX NOBR
Armchair max no arm



POLTRONA MAX NOBR
Armchair max no arm

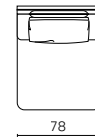

POLTRONA EXTRA
Armchair max



POLTRONA EXTRA NOBR
Armchair max no arm

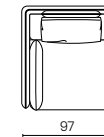

POLTRONA EXTRA NOBR
Armchair max no arm

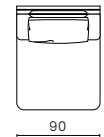

2 POSTI
2 seater

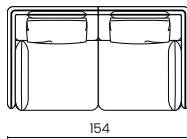

2 POSTI 1BR
2 seater 1 arm

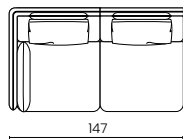

2 POSTI NO BR
2 seater no arm

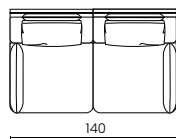

2 POSTI MAX
2 seater max

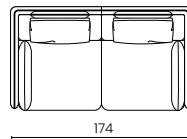

2 POSTI MAX 1BR
2 seater max 1 arm

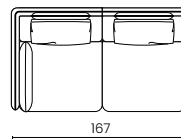

2 POSTI MAX NO BR
2 seater max no arm

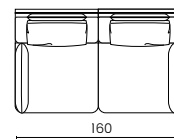

3 POSTI
3 seater

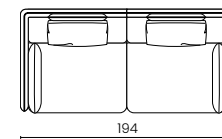

3 POSTI EXTRA 1BR
3 seater extra 1 arm

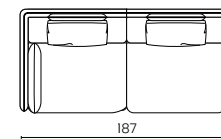

3 POSTI EXTRA NO BR
3 seater extra no arm

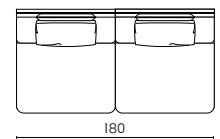

CHAISELONGUE EXTRA
Chaiselongue extra

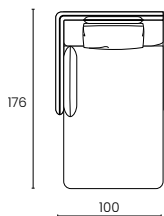

CHAISELONGUE MAX
Chaiselongue max

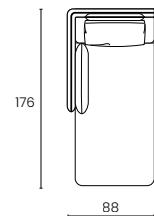

CHAISELONGUE
Chaiselongue

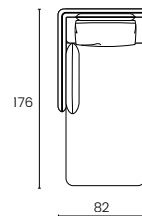

ANGOLO
Angle

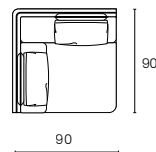



DATI TECNICI

Struttura: multistrato, abete
Poggiatesta: poliuretano densità 21 kg/m³
Spalliera: fiocco di fibra, poliuretano densità 30 kg/m³
Braccioli: poliuretano densità 21 kg/m³
Seduta: poliuretano densità 35 kg/m³
Piedi: acciaio lucido, canna di fucile
Piede conico in legno: Verifica le finiture in gamma

TECHNICAL DATA

Frame: plywood, fir
Headrest: polyurethane density 21 kg/m³
Backrest: Flake, polyurethane density 30 kg/m³
Armrests: polyurethane density 21 kg/m³
Seat: polyurethane density 35 kg/m³
Feet: shined steel, gun metal
Wooden conic leg: Check available wooden finishing

LISTINO | PRICE LIST

VANNA	LEATHER								FABRIC			MODAMILANO				
	VERSION	PESO	CBM	LUXURY	PREMIUM C	PREMIUM B	PREMIUM A	ROYAL B	ROYAL A	FABRIC C	FABRIC B	FABRIC A	MM D	MM C	MM B	MM A
2 SEATERS	62	1,26	3275	2901	2776	2651	2360	2194	2051	1962	1873	2764	2467	2170	1992	3031
2 SEATERS 1 ARMREST	58	1,22	2982	2650	2539	2428	2169	2021	1895	1815	1736	2528	2264	2000	1842	2766
2 SEATERS Max	66	1,42	3599	3183	3045	2906	2583	2398	2239	2140	2041	3031	2701	2371	2173	3328
2 SEATERS Max 1 ARMREST	62	1,38	3304	2929	2805	2680	2389	2222	2080	1991	1902	2793	2496	2199	2021	3060
2 SEATERS Max No ARMREST	58	1,28	2987	2654	2543	2433	2174	2026	1899	1820	1741	2612	2269	2005	1846	2770
2 SEATERS No ARMREST	48	1,12	2656	2365	2268	2171	1944	1815	1704	1635	1565	2258	2027	1796	1658	2466
3 SEATERS Extra	72	1,58	3972	3516	3364	3212	2858	2656	2484	2375	2266	3355	2992	2629	2411	3682
3 SEATERS Extra 1 ARMREST	68	1,54	3643	3230	3092	2955	2634	2450	2296	2197	2098	3088	2758	2428	2230	3385
3 SEATERS Extra No ARMREST	64	1,44	3326	2952	2827	2702	2411	2245	2102	2013	1924	2815	2518	2221	2043	3082
ANGLE	49	0,74	2561	2269	2172	2075	1849	1720	1609	1540	1470	2163	1932	1701	1563	2371
ARMCHAIR Extra	46	0,83	2367	2097	2007	1917	1706	1586	1483	1419	1355	1998	1784	1569	1440	2191
ARMCHAIR Extra 1 ARMREST	40	0,78	2157	1907	1824	1741	1547	1436	1341	1282	1222	1806	1608	1420	1301	1994
ARMCHAIR Extra NO ARMREST	36	0,72	1914	1688	1613	1537	1362	1261	1178	1124	1069	1614	1432	1251	1142	1777
ARMCHAIR Max	42	0,75	2191	1945	1863	1781	1589	1479	1388	1329	1269	1863	1665	1467	1349	2042
ARMCHAIR Max 1 ARMREST	38	0,68	1984	1759	1683	1608	1433	1332	1249	1195	1140	1685	1503	1332	1213	1848
ARMCHAIR Max NO ARMREST	34	0,62	1765	1557	1488	1418	1257	1164	1085	1036	986	1481	1316	1151	1052	1630
CHAISE LOUNGUE	52	1,22	2389	2139	2056	1973	1779	1668	1573	1514	1454	2048	1850	1652	1533	2226
CHAISE LOUNGUE Extra	60	1,53	2999	2666	2555	2444	2185	2038	1911	1832	1752	2544	2280	2016	1858	2782
CHAISE LOUNGUE Max	56	1,35	2701	2410	2313	2216	1990	1861	1750	1680	1611	2304	2073	1842	1704	2512
HEADREST	5	0,07	359	321	308	295	265	248	236	226	216	315	282	249	229	345
TERMINAL ARMCHAIR Extra	54	1,02	2807	2495	2392	2288	2045	1906	1788	1713	1639	2382	2134	1887	1738	2604
TERMINAL ARMCHAIR Max	50	0,92	2584	2296	2200	2104	1880	1752	1645	1575	1506	2199	1968	1737	1598	2407

Nei casi di versioni componibili, richiesti con rifinitura nel rivestimento scelto anziché con fodera come normalmente prodotta, verrà valutato un sovrapprezzo concordato con l'azienda. Si precisa che per esigenze di produzione ci potrebbero essere modifiche nei materiali, nei rivestimenti e nelle dimensioni del prodotto senza preavviso. I pesi ed i volumi riportati in scheda sono prettamente indicativi poiché suscettibili di tolleranze dettate dai processi produttivi. Nelle realizzazioni combinate in diversi rivestimenti, in presenza di categorie differenti, il prezzo da considerare è quello della categoria più alta.

In cases of modular versions, requested with finishing in the chosen upholstery instead of lining as normally produced, a surcharge agreed with the company will be considered. It should be noted that due to production requirements there may be changes in materials, upholstery and product dimensions without prior notice. The weights and volumes given in the sheet are purely indicative as they are susceptible to tolerances dictated by production processes. In combined realizations in different coatings, where there are different categories, the price to be considered is that of the highest category.



PREZZI ESEMPIO | PRICE EXAMPLE

MOD. FORMENTERA EXPO FIERA

Versione | version: 3 Posti 1 Bracciolo + Chaise Loungue Max | 3 Seaters 1 Arm + Chaise Loungue Max

Rivestimento | Covering: NQ-DU-80 DUBAI Blu reale (Fabric C)

Prezzo Listino | Price List: : FABRIC C 4.620 EURO

*Cuscini accessori e poggiatesta esclusi | *Cushions and backrest cushions excluded



Salone del Mobile. Milano

modamilano®
collection



CARATTERISTICHE PRINCIPALI

- ✓ SCHIENALE BASCULANTE
- ✓ POGGIATESTA REGOLABILE
- ✓ CUSCINATURA SFODERABILE
- ✓ PIEDI ALTI
- ✓ SEDUTA SUPER COMFORT

MAIN FEATURES

- ✓ TILTING BACKREST
- ✓ ADJUSTABLE HEADREST
- ✓ REMOVABLE CUSHIONING
- ✓ HIGH FEET
- ✓ SUPER COMFORT SEAT

E' un invito a vivere il divano in modi diversi, a seconda del numero degli ospiti, delle proprie esigenze, del momento della giornata. La sua doppia cuscinatura nella seduta è realizzata per esaltare la sensazione di comfort. Elemento che lo contraddistingue è il meccanismo di spalliera swift, che permette di ampliare la profondità di seduta e di diventare un'isola per il vostro riposo.

It is an invitation to experience the sofa in different ways, depending on the number of guests, one's needs, and the time of day. Its double cushioning in the seat is made to enhance the feeling of comfort. Its distinguishing element is the swift backrest mechanism, which allows you to expand the depth of seating and become an island for your rest.



DATI TECNICI

Struttura: multistrato, abete, faggio
Poggiatesta: poliuretano densità 21 kg/m³
Spalliera: poliuretano densità 30 kg/m³
Braccioli: poliuretano densità 21 kg/m³
Seduta: poliuretano densità 35 kg/m³
Piedi: acciaio lucido, acciaio spazzolato, canna di fucile, oro rosa.

TECHNICAL DATA

Frame: plywood, fir, beech
Headrest: polyurethane density 21 kg/m³
Backrest: polyurethane density 30 kg/m³
Armrests: polyurethane density 21 kg/m³
Seat: polyurethane density 35 kg/m³
Feet: shined steel, brushed steel, gun metal, golden pink.

modamilano®
collection

MODELLO FORMENTERA

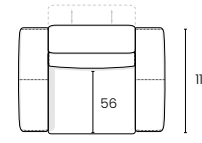
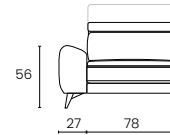
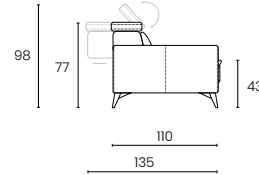

POLTRONA MAX TERM
Terminal Armchair Max

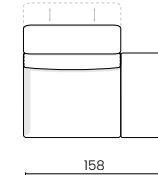

POLTRONA TERM
Terminal Armchair

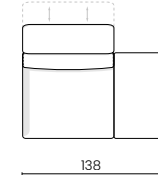

POLTRONA MAX
Armchair max

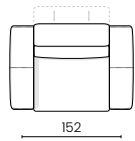

POLTRONA MAX 1 BR
Armchair max 1 arm

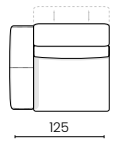

POLTRONA MAX NOBR
Armchair max no arm



POLTRONA
Armchair

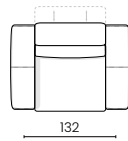

POLTRONA 1 BR
Armchair 1 arm

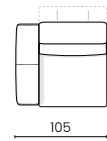

POLTRONA NO BR
Armchair no arm

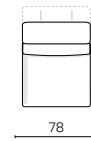

POLTRONA SMALL
Armchair small

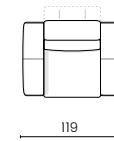

POLTRONA SMALL 1 BR
Armchair small no arm

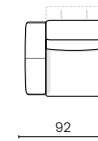

POLTRONA SMALL NOBR
Armchair small no arm

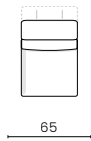

3 POSTI
3 seater

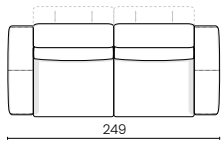

3 POSTI EXTRA 1 BR
3 seater extra 1 arm

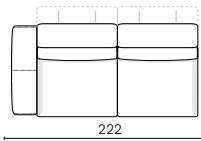

3 POSTI EXTRA NO BR
3 seater extra no arm

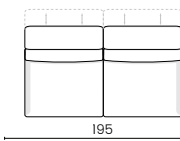

2 POSTI
2 seater

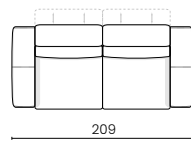

2 POSTI 1 BR
2 seater 1 arm

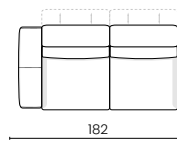

2 POSTI NO BR
2 seater no arm

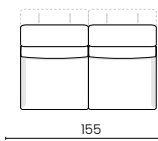

2 POSTI SMALL
2 seater small

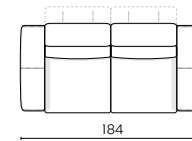

2 POSTI SMALL 1 BR
2 seater small 1 arm

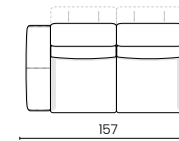

2 POSTI SMALL NO BR
2 seater small no arm

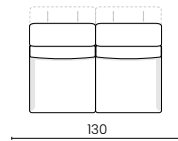

ANGOLO
Angle

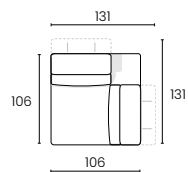

ANGOLO POUF
Angle pouf

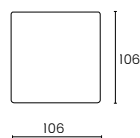

CHAISELONGUE MAX
Chaiselongue max

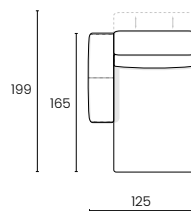

CHAISELONGUE
Chaiselongue

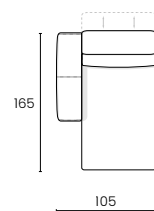

CHAISELONGUE SMALL
Chaiselongue small

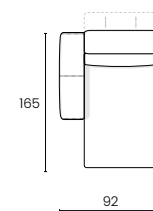

POUF SMALL
Pouf small

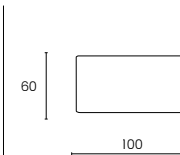

POUF TERMINALE
Pouf terminal

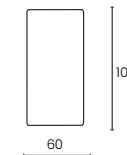

POUF CENTRALE
Pouf

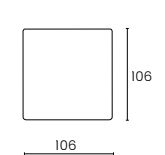

MODELLO FORMENTERA

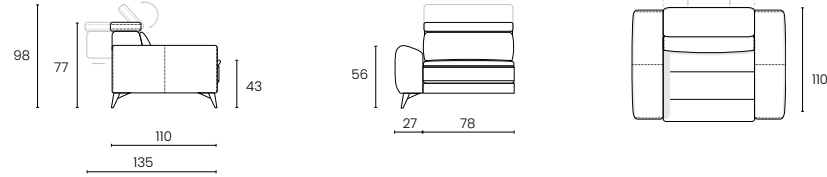

POLTRONA MAX TERM
Terminal Armchair Max

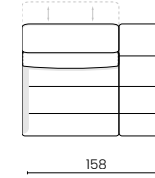

POLTRONA TERM
Terminal Armchair

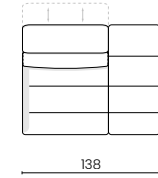

POLTRONA MAX
Armchair max

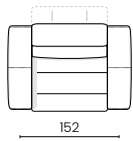

POLTRONA MAX 1 BR
Armchair max 1 arm

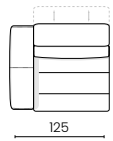

POLTRONA MAX NOBR
Armchair max no arm



POLTRONA
Armchair

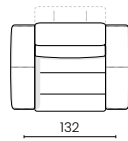

POLTRONA 1 BR
Armchair 1 arm

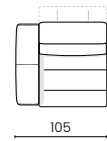

POLTRONA NO BR
Armchair no arm



POLTRONA SMALL
Armchair small

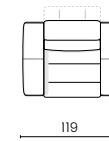

POLTRONA SMALL 1 BR
Armchair small no arm

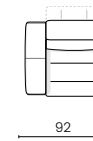

POLTRONA SMALL NOBR
Armchair small no arm



3 POSTI
3 seater



3 POSTI EXTRA 1 BR
3 seater extra 1 arm

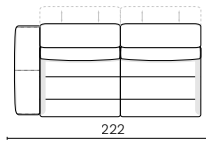

3 POSTI EXTRA NO BR
3 seater extra no arm

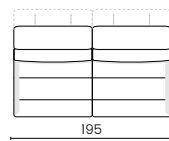

2 POSTI
2 seater

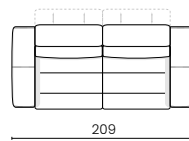

2 POSTI 1 BR
2 seater 1 arm

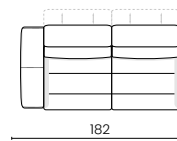

2 POSTI NO BR
2 seater no arm

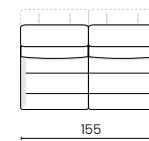

2 POSTI SMALL
2 seater small

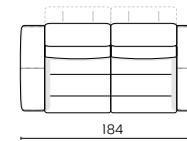

2 POSTI SMALL 1 BR
2 seater small 1 arm

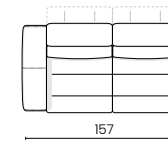

2 POSTI SMALL NO BR
2 seater small no arm

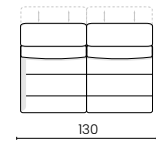

ANGOLO
Angle

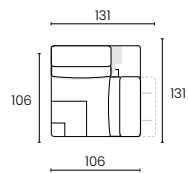

ANGOLO POUF
Angle pouf

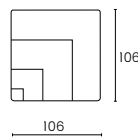

CHAISELONGUE MAX
Chaiselongue max

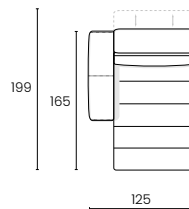

CHAISELONGUE
Chaiselongue

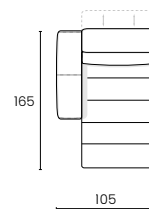

CHAISELONGUE SMALL
Chaiselongue small

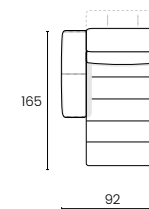

POUF SMALL
Pouf small

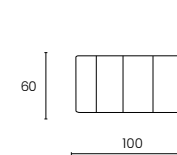

POUF TERMINALE
Pouf terminal

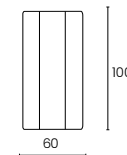

POUF CENTRALE
Pouf

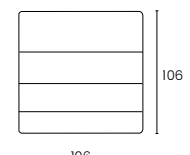

MODELLO FORMENTERA



LISTINO | PRICE LIST

FORMENTERA OPEN	LEATHER								FABRIC			MODAMILANO				
VERSION	PESO	CBM	LUXURY	PREMIUM C	PREMIUM B	PREMIUM A	ROYAL B	ROYAL A	FABRIC C	FABRIC B	FABRIC A	MM D	MM C	MM B	MM A	GREEN
2 SEATERS	76	1,77	4340	3803	3623	3444	3026	2787	2585	2457	2328	3615	3186	2757	2499	4000
2 SEATERS 1 ARMREST	70	1,54	4031	3535	3369	3204	2818	2598	2412	2293	2174	3362	2966	2570	2333	3719
2 SEATERS NO ARMREST	60	1,31	3746	3292	3140	2989	2635	2433	2263	2154	2045	3134	2771	2408	2191	3461
2 SEATERS Small	70	1,56	4056	3560	3395	3229	2844	2623	2437	2318	2199	3387	2991	2595	2358	3744
2 SEATERS Small 1 ARMREST	67	1,33	3751	3296	3145	2993	2640	2438	2268	2159	2050	3139	2776	2413	2195	3466
2 SEATERS Small NO ARMREST	62	1,1	3426	3013	2876	2738	2417	2233	2079	1980	1881	2871	2541	2211	2013	3168
3 SEATERS	93	2,11	5118	4447	4223	4000	3478	3179	2839	2700	2561	3947	3485	3023	2746	4363
3 SEATERS 1 ARMREST	83	1,88	4419	3882	3703	3523	3105	2866	2664	2536	2407	3694	3265	2836	2579	4080
3 SEATERS NO ARMREST	73	1,65	4095	3597	3432	3266	2879	2658	2471	2352	2233	3421	3025	2629	2391	3777
ANGLE	50	0,87	2533	2262	2172	2082	1872	1752	1649	1585	1520	2164	1949	1735	1606	2357
ANGLE POUF	40	0,52	1531	1386	1337	1289	1175	1111	1055	1021	986	1333	1217	1102	1032	1436
ARMCHAIR	53	1,12	2454	2166	2070	1974	1750	1622	1515	1445	1376	2069	1838	1607	1469	2277
ARMCHAIR 1 ARMREST	43	0,89	2156	1909	1827	1745	1553	1444	1353	1293	1234	1828	1630	1432	1313	2006
ARMCHAIR Max 1 ARMREST	47	1,06	2431	2143	2047	1951	1727	1599	1492	1423	1353	2046	1815	1584	1446	2254
ARMCHAIR Max NO ARMREST	50	0,83	2126	1880	1797	1715	1523	1414	1323	1263	1204	1798	1600	1402	1283	1976
ARMCHAIR MAXI	58	1,29	2737	2407	2297	2187	1931	1784	1662	1582	1503	2295	2031	1767	1609	2533
ARMCHAIR NO ARMREST	34	0,66	1851	1646	1578	1510	1350	1259	1184	1134	1085	1580	1415	1250	1151	1728
ARMCHAIR Small	50	1,01	2229	1982	1900	1818	1626	1517	1426	1366	1307	1901	1703	1505	1386	2079
ARMCHAIR Small 1 ARMREST	40	0,78	1626	1721	1653	1585	1425	1334	1259	1209	1160	1655	1490	1325	1226	1803
ARMCHAIR Small NO ARMREST	42	0,55	1733	1570	1516	1461	1334	1261	1202	1162	1123	1519	1387	1255	1176	1638
CENTRAL POUF	40	0,52	1444	1298	1250	1201	1088	1023	968	933	899	1245	1130	1014	945	1349
CENTRAL POUF Small	18	0,26	952	878	853	829	771	738	718	698	678	876	810	744	705	936
CHAISE LOUNGUE	55	1,33	2790	2478	2374	2270	2028	1889	1770	1696	1622	2364	2117	1869	1721	2587
CHAISE LOUNGUE Max	67	1,59	3111	2758	2640	2522	2248	2090	1956	1878	1788	2629	2349	2068	1900	2881
CHAISE LOUNGUE Small	55	1,17	2536	2266	2176	2086	1875	1755	1652	1588	1524	2167	1953	1738	1609	2360
TERMINAL ARMCHAIR	42	1,47	3157	2744	2607	2469	2148	1964	1810	1711	1612	2602	2272	1942	1744	2899
TERMINAL ARMCHAIR Max	50	1,92	3235	2822	2685	2547	2226	2042	1888	1789	1690	2680	2350	2020	1822	2977
TERMINAL POUF	18	0,26	997	913	886	858	793	756	725	705	685	883	817	751	711	898

Nei casi di versioni componibili, richiesti con rifinitura nel rivestimento scelto anziché con fodera come normalmente prodotta, verrà valutato un sovrapprezzo concordato con l'azienda. Si precisa che per esigenze di produzione ci potrebbero essere modifiche nei materiali, nei rivestimenti e nelle dimensioni del prodotto senza preavviso. I pesi ed i volumi riportati in scheda sono prettamente indicativi poiché suscettibili di tolleranze dettate dai processi produttivi. Nelle realizzazioni combinate in diversi rivestimenti, in presenza di categorie differenti, il prezzo da considerare è quello della categoria più alta.

In cases of modular versions, requested with finishing in the chosen upholstery instead of lining as normally produced, a surcharge agreed with the company will be considered. It should be noted that due to production requirements there may be changes in materials, upholstery and product dimensions without prior notice. The weights and volumes given in the sheet are purely indicative as they are susceptible to tolerances dictated by production processes. In combined realizations in different coatings, where there are different categories, the price to be considered is that of the highest category.



PREZZI ESEMPIO | PRICE EXAMPLE

MOD. FORMENTERA EXPO FIERA

Versione | version: 3 POSTI LETTO | 3 Seaters Sofabed

Rivestimento | Covering: NQ-4001 PREMIUM NATURAL Bianco (Premium A) + dettagli NQ-MM-20 MADEMOISELLE PERLA (MM B)

Prezzo Listino | Price List: : PREMIUM A 4.385 EURO

*Cuscini accessori e poggiatestai esclusi | *Cushions and backrest cushions excluded



Salone del Mobile. Milano



modamilano[®]
collection



modamilano[®]



modamilano[®]



modamilano[®]



modamilano[®]

CARATTERISTICHE PRINCIPALI

- ✓ CUSCINATURA REMOVIBILE
- ✓ PRONTO LETTO
- ✓ POGGIATESTA REGOLABILI
- ✓ PIEDI ALTI
- ✓ PORTA CUSCINI
- ✓ MATERASSO CON MEMORY
- ✓ RETE ELETTRORALDATA

MAIN FEATURES

- ✓ REMOVABLE CUSHIONING
- ✓ BED READY
- ✓ ADJUSTABLE HEADRESTS
- ✓ HIGH FEET
- ✓ PILLOW HOLDER
- ✓ MATTRESS WITH MEMORY
- ✓ ELECTROWELDED NET

3 POSTI

3 seater

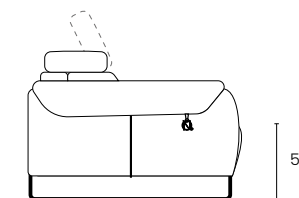
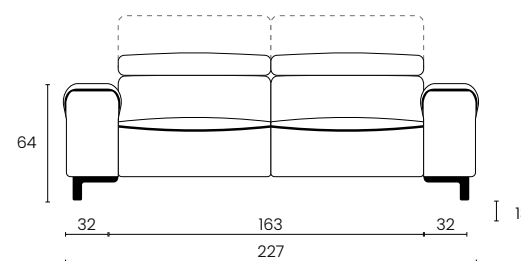
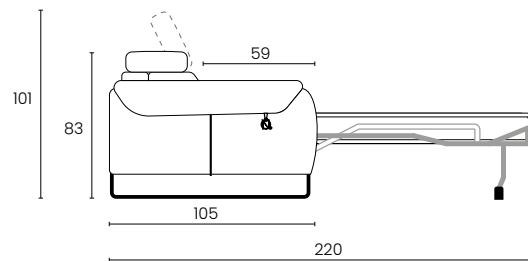



DATI TECNICI

Struttura: multistrato, abete, faggio
Poggiatesta: poliuretano densità 30 kg/m³
Spalliera: poliuretano densità 30 kg/m³
Braccioli: poliuretano densità 35 kg/m³
Seduta: poliuretano densità 35 kg/m³
Piedi: acciaio lucido, canna di fucile
Materasso: D30 memory
Rete: extra smart con cinghie elastiche

TECHNICAL DATA

Frame: plywood, fir, beech
Headrest: polyurethane density 30 kg/m³
Backrest: polyurethane density 30 kg/m³
Armrests: polyurethane density 35 kg/m³
Seat: polyurethane density 35 kg/m³
Feet: gun metal, canna di fucile
Mattress: D30 memory
Bed base: extra smart with elastic straps

Divano letto Noela, un design moderno e raffinato, dettagli accurati ed eleganti piedi in metallo nascondono un comodo letto trasformabile. Noela è un progetto che riqualifica la categoria del divano letto elevandola ad un livello superiore in termini di eleganza e comodità.

Noela sofa bed, a modern and refined design, accurate details and elegant metal feet hide a comfortable convertible bed. Noela is a design that redevelops the sofa bed category by elevating it to a higher level in terms of elegance and comfort.

LISTINO | PRICE LIST

NOELA	LEATHER								FABRIC			MODAMILANO				
	VERSION	PESO	CBM	LUXURY	PREMIUM C	PREMIUM B	PREMIUM A	ROYAL B	ROYAL A	FABRIC C	FABRIC B	FABRIC A	MM D	MM C	MM B	MM A
3 SEATERS BEDSOFA	170	1,85	5078	4662	4523	4385	4061	3876	3718	3619	3520	4510	4180	3850	3652	4807

Nei casi di versioni componibili, richiesti con rifinitura nel rivestimento scelto anziché con fodera come normalmente prodotto, verrà valutato un sovrapprezzo concordato con l'azienda. Si precisa che per esigenze di produzione ci potrebbero essere modifiche nei materiali, nei rivestimenti e nelle dimensioni del prodotto senza preavviso. I pesi ed i volumi riportati in scheda sono prettamente indicativi poiché suscettibili di tolleranze dettate dai processi produttivi. Nelle realizzazioni combinate in diversi rivestimenti, in presenza di categorie differenti, il prezzo da considerare è quello della categoria più alta.

In cases of modular versions, requested with finishing in the chosen upholstery instead of lining as normally produced, a surcharge agreed with the company will be considered. It should be noted that due to production requirements there may be changes in materials, upholstery and product dimensions without prior notice. The weights and volumes given in the sheet are purely indicative as they are susceptible to tolerances dictated by production processes. In combined realizations in different coatings, where there are different categories, the price to be considered is that of the highest category.



PREZZI ESEMPIO - PRICE EXAMPLE

MOD. ALICE EXPO FIERA

Versione - version: Poltroncina + 2 Posti + Pouf Piedi Dorati | Armchair + 2 Seaters + Pouf Golden Legs

Rivestimento - Covering: NQ-RI-13 RICCIOLO PANNA (MM C)

Prezzo Listino - Price List: MM C 2.928 EURO

*Cuscini accessori e poggiatesta esclusi - *Cushions and backrest cushions excluded



Salone del Mobile. Milano



SCHEDA TECNICA
specification sheet

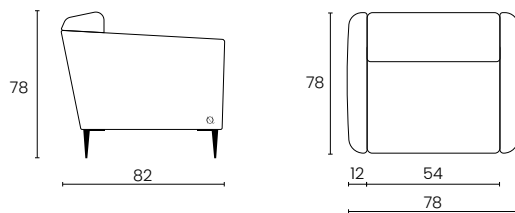

POGGIATESTA
headrest

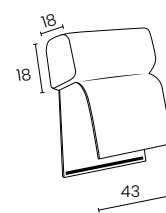

POLTRONA
Armchair

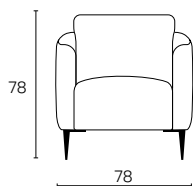

2 POSTI
2 seater

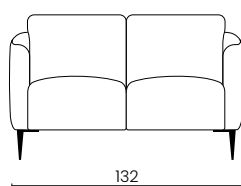

3 POSTI
3 seater

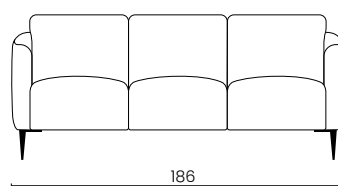

POUF
pouf

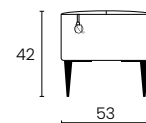

POUF CON ROTELLE
pouf with wheels

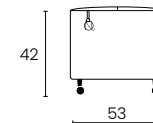

CARATTERISTICHE PRINCIPALI

- ✓ POGGIATESTA SGANCIABILE
- ✓ PIEDI ALTI
- ✓ SEDUTA COMFROT

MAIN FEATURES

- ✓ DETACHABLE HEADREST
- ✓ HIGH FEET
- ✓ COMFROT SEAT



DATI TECNICI

Struttura: multistrato, abete, faggio
Poggiatesta: poliuretano densità 25 kg/m³
Spalliera: poliuretano densità 35 kg/m³
Braccioli: poliuretano densità 35 kg/m³
Seduta: poliuretano densità 35 kg/m³
Piedi: acciaio lucido, canna di fucile, golden*

TECHNICAL DATA

Frame: plywood, fir, beech
Headrest: polyurethane density 25 kg/m³
Backrest: polyurethane density 35 kg/m³
Armrests: polyurethane density 35 kg/m³
Seat: polyurethane density 35 kg/m³
Feet: Shined metal, Gun Metal, Golden

Linee semplici e graziose descrivono la collezione Alice. Elegante rivestita in tessuto o pelle, favolosa con i rivestimenti floreali esclusivi NicolaQuinto.

Simple, graceful lines describe the Alice collection. Elegant upholstered in fabric or leather, fabulous with exclusive NICOLAQUINTO® floral upholstery.

LISTINO | PRICE LIST

ALICE			LEATHER						FABRIC			MODAMILANO				
VERSION	PESO	CBM	LUXURY	PREMIUM C	PREMIUM B	PREMIUM A	ROYAL B	ROYAL A	FABRIC C	FABRIC B	FABRIC A	MM D	MM C	MM B	MM A	GREEN
2 SEATERS	37	0,84	1787	1580	1510	1441	1279	1187	1108	1058	1009	1504	1339	1174	1075	1652
3 SEATERS	50	1,19	2383	2092	1995	1898	1671	1542	1431	1362	1293	1986	1755	1524	1385	2193
CUDDLECHAIR	24	0,5	1271	1126	1077	1029	916	851	795	761	726	1073	957	842	772	1176
HEADREST	5	0,01	275	234	220	206	174	155	140	129	119	219	185	152	133	148
POUF	8,6	0,12	513	466	450	434	397	376	360	348	336	455	416	376	352	491
POUF WITH WHEELS	10	0,12	712	638	613	588	531	498	470	452	434	612	553	494	458	666

*GOLDEN: 72 €

Nei casi di versioni componibili, richiesti con rifinitura nel rivestimento scelto anziché con fodera come normalmente prodotto, verrà valutato un sovrapprezzo concordato con l'azienda. Si precisa che per esigenze di produzione ci potrebbero essere modifiche nei materiali, nei rivestimenti e nelle dimensioni del prodotto senza preavviso. I pesi ed i volumi riportati in scheda sono prettamente indicativi poiché suscettibili di tolleranze dettate dai processi produttivi. Nelle realizzazioni combinate in diversi rivestimenti, in presenza di categorie differenti, il prezzo da considerare è quello della categoria più alta.

In cases of modular versions, requested with finishing in the chosen upholstery instead of lining as normally produced, a surcharge agreed with the company will be considered. It should be noted that due to production requirements there may be changes in materials, upholstery and product dimensions without prior notice. The weights and volumes given in the sheet are purely indicative as they are susceptible to tolerances dictated by production processes. In combined realizations in different coatings, where there are different categories, the price to be considered is that of the highest category.



PREZZI ESEMPIO | PRICE EXAMPLE

MOD. GIOTTO EXPO FIERA

Versione | version: 3 Posti | 3 Seaters

Rivestimento | Covering: NQ-ME-20001 PELLE VEGANA MotherEarth (GREEN)

Prezzo Listino | Price List: GREEN 3.810 EURO

*Cuscini accessori e poggiatesta esclusi | *Cushions and backrest cushions excluded



Salone del Mobile. Milano

CARATTERISTICHE PRINCIPALI

- ✓ CUSCINATURA SFODERABILE
- ✓ PIEDI ALTI
- ✓ SEDUTA SUPER COMFORT

MAIN FEATURES

- ✓ REMOVABLE CUSHIONING
- ✓ HIGH FEET
- ✓ SUPER COMFORT SEAT



E' un invito a vivere il divano in modi diversi, a seconda del numero degli ospiti, delle proprie esigenze, del momento della giornata. La sua doppia cuscinatura nella seduta è realizzata per esaltare la sensazione di comfort. Elemento che lo contraddistingue è il meccanismo di spalliera swift, che permette di ampliare la profondità di seduta e di diventare un'isola per il vostro riposo.

It is an invitation to experience the sofa in different ways, depending on the number of guests, one's needs, and the time of day. Its double cushioning in the seat is made to enhance the feeling of comfort. Its distinguishing element is the swift backrest mechanism, which allows you to expand the depth of seating and become an island for your rest.



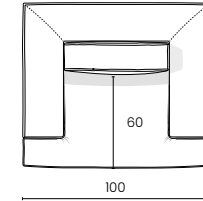
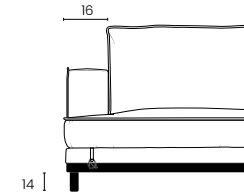
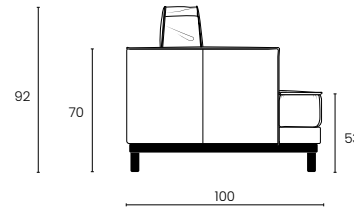

POLTRONA MAX

Armchair max

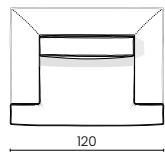

POLTRONA MAX 1 BR

Armchair max 1 arm

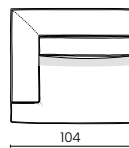

POLTRONA MAX NOBR

Armchair max no arm



POLTRONA

Armchair

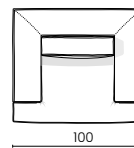

POLTRONA 1 BR

Armchair 1 arm

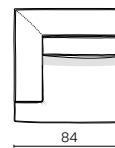

POLTRONA NO BR

Armchair no arm



POUF CENTRALE

Pouf

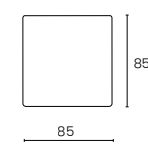

3 POSTI

3 seater

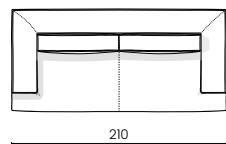

3 POSTI 1BR

3 seater 1 arm

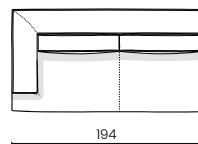

2 POSTI

2 seater

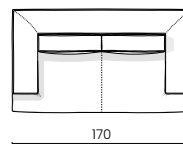

2 POSTI 1BR

2 seater 1 arm

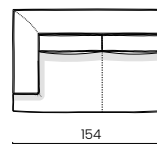

CHAISELONGUE MAX

Chaiselongue max

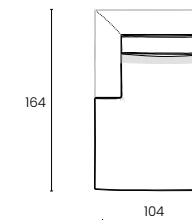

CHAISELONGUE

Chaiselongue

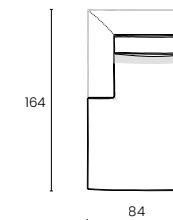



DATI TECNICI

Struttura: multistrato, abete, faggio

Spalliera: fiocco

Braccioli: poliuretano densità 28 kg/m³

Seduta: poliuretano densità 35 kg/m³ + piuma d'oca

Base legno - Verifica le finiture in gamma

Base tubolare - Acciaio lucido

TECHNICAL DATA

Frame: plywood, fir, beech

Backrest: flake

Armrests: polyurethane density 28 kg/m³

Seat: polyurethane density 35 kg/m³ + goose feather

Wooden base: Check available wooden finishing

Tubular base: Shined steel

LISTINO | PRICE LIST

GIOTTO	LEATHER								FABRIC			MODAMILANO				
VERSION	PESO	CBM	LUXURY	PREMIUM C	PREMIUM B	PREMIUM A	ROYAL B	ROYAL A	FABRIC C	FABRIC B	FABRIC A	MM D	MM C	MM B	MM A	GREEN
2 SEATERS	70	1,56	3691	3275	3137	2998	2675	2490	2332	2233	2134	3124	2794	2464	2266	3421
2 SEATERS 1 ARMREST	60	1,42	3312	2938	2813	2688	2397	2231	2088	2000	1910	2801	2504	2207	2029	3068
3 SEATERS	80	1,93	4108	3650	3498	3345	2990	2786	2612	2503	2394	3483	3120	2757	2540	3810
3 SEATERS 1 ARMREST	70	1,78	3729	3313	2174	3036	2712	2527	2369	2270	2171	3161	2831	2501	2303	3458
ARMCHAIR	40	0,92	2343	2075	1985	1895	1684	1564	1461	1397	1333	1976	1762	1547	1419	2169
ARMCHAIR 1 ARMREST	35	0,77	2051	1823	1747	1670	1492	1391	1304	1249	1195	1739	1558	1376	1267	1903
ARMCHAIR Max	45	1,1	2598	2307	2210	2113	1887	1757	1646	1577	1508	2201	1970	1739	1603	2409
ARMCHAIR Max 1 ARMREST	40	0,96	2295	2049	1927	1885	1693	1583	1492	1433	1374	1968	1769	1571	1453	2146
ARMCHAIR Max NO ARMREST	35	0,81	1995	1790	1772	1654	1495	1403	1328	1279	1229	1724	1559	1394	1295	1873
ARMCHAIR NO ARMREST	30	0,63	1741	1554	1491	1429	1283	1200	1129	1084	1040	1485	1337	1188	1099	1619
CHAISE LONG MAX	65	1,57	3433	3059	2934	2810	2519	2352	2210	2120	2031	2922	2625	2328	2150	3190
CHAISE LOUNGUE	55	1,27	2943	2640	2539	2438	2203	2068	1981	1902	1823	2615	2351	2087	1928	2852
POUF	25	0,33	1449	1303	1255	1206	1093	1028	973	938	904	1250	1135	1019	950	1354

Nei casi di versioni componibili, richiesti con rifinitura nel rivestimento scelto anziché con fodera come normalmente prodotto, verrà valutato un sovrapprezzo concordato con l'azienda. Si precisa che per esigenze di produzione ci potrebbero essere modifiche nei materiali, nei rivestimenti e nelle dimensioni del prodotto senza preavviso. I pesi ed i volumi riportati in scheda sono prettamente indicativi poiché suscettibili di tolleranze dettate dai processi produttivi. Nelle realizzazioni combinate in diversi rivestimenti, in presenza di categorie differenti, il prezzo da considerare è quello della categoria più alta.

In cases of modular versions, requested with finishing in the chosen upholstery instead of lining as normally produced, a surcharge agreed with the company will be considered. It should be noted that due to production requirements there may be changes in materials, upholstery and product dimensions without prior notice. The weights and volumes given in the sheet are purely indicative as they are susceptible to tolerances dictated by production processes. In combined realizations in different coatings, where there are different categories, the price to be considered is that of the highest category.



PREZZI ESEMPIO | PRICE EXAMPLE

MOD. CADNY EXPO FIERA

Versione | version: nr 3 Poltrone Max + Angolo + Chaise Loungue Max | nr 3 Armchair Max + Angle + Chaise Loungue Max

Rivestimento | Covering: NQ-4023 PREMIUM NATURAL Creta (Premium A) + NQ-MG-207 MAGENTO JEANS (MM A) + Dettagli NQ-DU-70 DUBAI Caramello (Fabric C)

Prezzo Listino | Price List: PREMIUM A 9.538 EURO

*Cuscini accessori e poggiatesta esclusi | *Cushions and backrest cushions excluded



Salone del Mobile. Milano



CARATTERISTICHE PRINCIPALI

- ✓ COMPONIBILE
- ✓ SCHIENALE BASCULANTE
- ✓ POGGIATESTA REGOLABILE
- ✓ CUSCINATURA SFODERABILE
- ✓ PIEDI ALTI
- ✓ SEDUTA SUPER COMFORT

MAIN FEATURES

- ✓ MODULAR
- ✓ TILTING BACKREST
- ✓ ADJUSTABLE HEADREST
- ✓ REMOVABLE CUSHIONING
- ✓ SUPER COMFORT SEAT



E' un invito a vivere il divano in modi diversi, a seconda del numero degli ospiti, delle proprie esigenze, del momento della giornata. La sua doppia cuscinatura nella seduta è realizzata per esaltare la sensazione di comfort. Elemento che lo contraddistingue è il meccanismo di spalliera swift, che permette di ampliare la profondità di seduta e di diventare un'isola per il vostro riposo.

It is an invitation to experience the sofa in different ways, depending on the number of guests, one's needs, and the time of day. Its double cushioning in the seat is made to enhance the feeling of comfort. Its distinguishing element is the swift backrest mechanism, which allows you to expand the depth of seating and become an island for your rest.

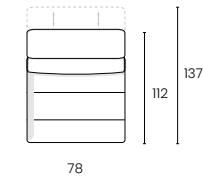
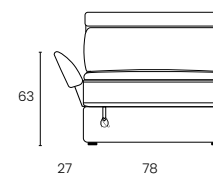
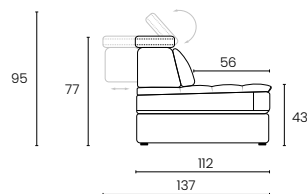

POLTRONA MAX NOBR
Armchair max no arm



POLTRONA NO BR
Armchair no arm



POLTRONA SMALL NOBR
Armchair small no arm



3 POSTI EXTRA NO BR
3 seater extra no arm

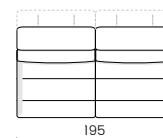

2 POSTI NO BR
2 seater no arm

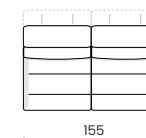

ANGOLO
Angle

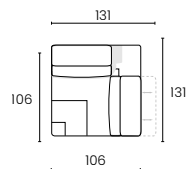

ANGOLO POUF
Angle pouf

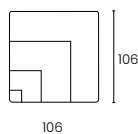

CHAISELONGUE MAX
Chaiselongue max

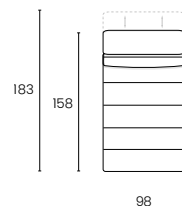

CHAISELONGUE
Chaiselongue

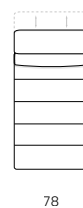

CHAISELONGUE SMALL
Chaiselongue small

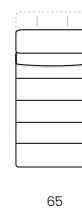

POUF SMALL
Pouf small

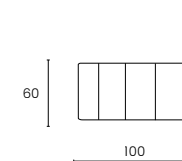

POUF TERMINALE
Pouf terminal

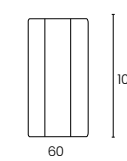

POUF CENTRALE
Pouf

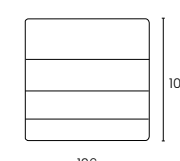



DATI TECNICI

Struttura: multistrato, abete, faggio
Poggiatesta: poliuretano densità 21 kg/m³
Spalliera: poliuretano densità 30 kg/m³
Braccioli: poliuretano densità 21 kg/m³
Seduta: poliuretano densità 35 kg/m³
Piedi: PVC

TECHNICAL DATA

Frame: plywood, fir, beech
Headrest: polyurethane density 21 kg/m³
Backrest: polyurethane density 30 kg/m³
Armrests: polyurethane density 21 kg/m³
Seat: polyurethane density 35 kg/m³
Feet: PVC

modamilano®
collection

LISTINO | PRICE LIST

CANDY	LEATHER								FABRIC			MODAMILANO				GREEN
	VERSION	PESO	CBM	LUXURY	PREMIUM C	PREMIUM B	PREMIUM A	ROYAL B	ROYAL A	FABRIC C	FABRIC B	FABRIC A	MM D	MM C	MM B	
2 SEATERS	70	1,34	3698	3240	3088	2935	2579	2376	2202	2093	1984	3073	2710	2347	2129	3400
3 SEATERS	85	1,68	4066	3567	3401	3235	2847	2625	2435	2316	2197	3385	2989	2593	2536	3742
ANGLE	50	0,48	2545	2254	2157	2059	1833	1704	1593	1523	1454	2147	1916	1685	1547	2355
ANGLE POUF	30	0,48	1430	1285	1236	1188	1074	1010	954	920	885	1232	1116	1000	931	1135
ARMCHAIR	33	0,67	1830	1625	1557	1488	1329	1238	1163	1113	1064	1559	1394	1229	1130	1707
ARMCHAIR Max	38	0,85	2104	1790	1774	1692	1500	1390	1298	1238	1179	1773	1575	1377	1258	1951
ARMCHAIR Small	27	0,56	1627	1464	1410	1355	1228	1155	1096	1056	1017	1413	1281	1149	1070	1532
ARMREST	7	0,11	438	397	383	369	337	318	302	293	283	382	349	316	296	411
CENTRAL POUF	30	0,48	1343	1198	1149	1101	988	923	868	833	798	1145	1029	914	845	1249
CENTRAL POUF Small	17	0,28	868	785	757	730	665	628	596	576	557	755	689	623	583	814
CHAISE LOUNGUE	48	0,95	2712	2379	2269	2158	1899	1751	1624	1545	1466	2258	1994	1730	1572	2496
CHAISE LOUNGUE Max	50	1,19	3026	2652	2527	2403	2112	1946	1803	1714	1624	1516	1219	1922	1743	1783
CHAISE LOUNGUE Small	46	0,79	2484	2193	2096	1999	1772	1643	1532	1463	1393	2086	1855	1624	1486	2294
TERMINAL POUF	17	0,28	883	800	772	744	679	642	611	591	571	769	703	637	598	829

Nei casi di versioni componibili, richiesti con rifinitura nel rivestimento scelto anziché con fodera come normalmente prodotto, verrà valutato un sovrapprezzo concordato con l'azienda. Si precisa che per esigenze di produzione ci potrebbero essere modifiche nei materiali, nei rivestimenti e nelle dimensioni del prodotto senza preavviso. I pesi ed i volumi riportati in scheda sono prettamente indicativi poiché suscettibili di tolleranze dettate dai processi produttivi. Nelle realizzazioni combinate in diversi rivestimenti, in presenza di categorie differenti, il prezzo da considerare è quello della categoria più alta.

In cases of modular versions, requested with finishing in the chosen upholstery instead of lining as normally produced, a surcharge agreed with the company will be considered. It should be noted that due to production requirements there may be changes in materials, upholstery and product dimensions without prior notice. The weights and volumes given in the sheet are purely indicative as they are susceptible to tolerances dictated by production processes. In combined realizations in different coatings, where there are different categories, the price to be considered is that of the highest category.



PREZZI ESEMPIO | PRICE EXAMPLE

MOD. TULIPANO EXPO FIERA

Versione | version: 3 Posti 1 Bracciolo + Angolo + Poltrona No Bracciolo Max + Pouf Terminale | 3 Seaters 1 Arm + Angle +
Armchair No Arms Max + Terminal Pouf

Rivestimento | Covering: NQ-7005 LUXURY STONE Testamoro (Luxury)

Prezzo Listino | Price List: : LUXURY 10.467 EURO

*Cuscini accessori e poggiatesta esclusi | *Cushions and backrest cushions excluded



Salone del Mobile. Milano



CARATTERISTICHE PRINCIPALI

- ✓ CUSCINATURA SFODERABILE
- ✓ PIEDI ALTI
- ✓ SEDUTA SUPER COMFORT

MAIN FEATURES

- ✓ REMOVABLE CUSHIONING
- ✓ HIGH FEET
- ✓ SUPER COMFORT SEAT



Soffice ed invitante sono sicuramente gli aggettivi che meglio descrivono OXFORD. Dall'aspetto informale e dalle dimensioni importanti, le sue linee ci riportano a geometrie regolari ingentilite da morbidi contorni. Gli elementi che contraddistinguono questo sofà sono le importanti cuscinate, rifinite da ricercate cuciture a taglio vivo, ed una seduta super soft, che offre il massimo del comfort per momenti di totale relax.

Soft and inviting are surely the adjectives that best describe OXFORD. With its informal appearance and important dimensions, its lines take us back to regular geometries softened by soft contours. The elements that distinguish this sofa are the important cushions, finished with refined raw-cut stitching, and a super soft seat that offers maximum comfort for moments of total relaxation.

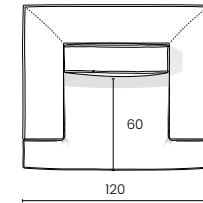
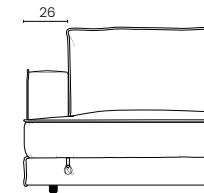
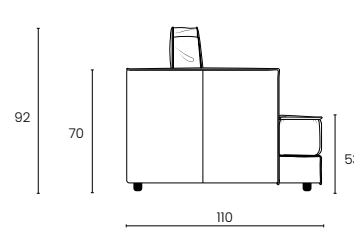

POLTRONA MAX
Armchair max

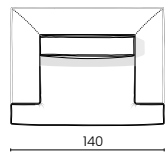

POLTRONA MAX 1 BR
Armchair max 1 arm

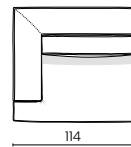

POLTRONA MAX NOBR
Armchair max no arm



POLTRONA
Armchair

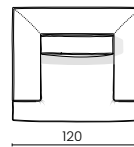

POLTRONA 1 BR
Armchair 1 arm

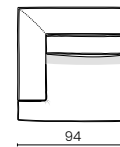

POLTRONA NO BR
Armchair no arm



POUF CENTRALE
Pouf

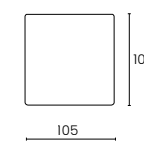

POUF TERMINALE
Pouf terminal

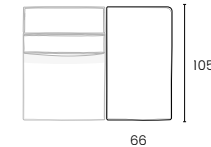

3 POSTI
3 seater

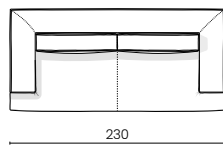

3 POSTI 1BR
3 seater 1 arm

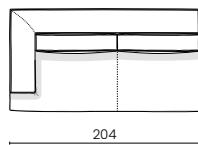

3 POSTI NO BR
3 seater no arm

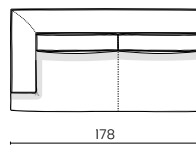

2 POSTI
2 seater

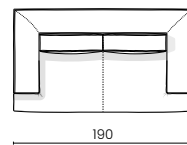

2 POSTI 1BR
2 seater 1 arm

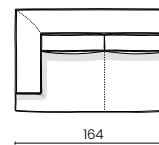

2 POSTI NO BR
2 seater no arm

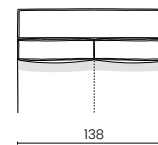

CHAISELONGUE MAX
Chaiselongue max

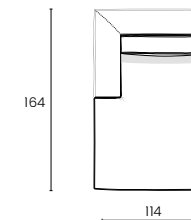

CHAISELONGUE
Chaiselongue

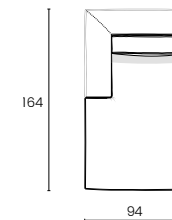



DATI TECNICI

Struttura: multistrato, abete, faggio

Spalliera: fiocco

Braccioli: poliuretano densità 28 kg/m³

Seduta: poliuretano densità 35 kg/m³ + piuma d'oca

Piedi: PVC

TECHNICAL DATA

Frame: plywood, fir, beech

Backrest: Flake

Armrests: polyurethane density 28 kg/m³

Seat: polyurethane density 35 kg/m³ + goose feather

Feet: PVC

LISTINO | PRICE LIST

OXFORD			LEATHER						FABRIC			MODAMILANO				
VERSION	PESO	CBM	LUXURY	PREMIUM C	PREMIUM B	PREMIUM A	ROYAL B	ROYAL A	FABRIC C	FABRIC B	FABRIC A	MM D	MM C	MM B	MM A	GREEN
2 SEATERS	80	1,99	4453	3844	3642	3439	2965	2694	2465	2319	2174	3629	3144	2659	2368	4066
2 SEATERS 1 ARMREST	75	1,71	4033	3466	3277	3088	2646	2394	2180	2045	1909	3265	2813	2361	2090	3672
2 SEATERS NO ARMREST	70	1,44	3634	3108	2933	2757	2349	2115	1917	1791	1665	2923	2504	2085	1833	3300
3 SEATERS	90	2,4	4892	4242	4025	3808	3302	3013	2768	2612	2457	4011	3493	2975	2664	4478
3 SEATERS 1 ARMREST	85	2,13	4473	3864	3661	3458	2985	2714	2485	2339	2193	3649	3164	2678	2387	4085
3 SEATERS NO ARMREST	80	1,86	4076	3509	3320	3131	2690	2438	2224	2088	1952	3309	2857	2405	2133	3716
ANGLE	58	1,05	2686	2354	2243	2132	1873	1725	1599	1520	1440	2232	1968	1704	1576	2470
ARMCHAIR	60	1,25	2459	2168	2071	1974	1748	1619	1527	1453	1379	2121	1874	1626	1478	2344
ARMCHAIR 1 ARMREST	55	0,98	2188	1910	1817	1724	1507	1384	1278	1211	1145	1808	1587	1366	1233	2007
ARMCHAIR Max	60	1,25	2908	2555	2437	2319	2044	1887	1752	1668	1584	2426	2145	1865	1696	2678
ARMCHAIR MAX 1 ARMREST	58	1,19	2540	2223	2117	2011	1764	1622	1504	1427	1351	2113	1859	1605	1453	2342
ARMCHAIR MAX NON ARMREST	53	0,92	2147	1856	1759	1662	1435	1306	1195	1126	1057	1750	1519	1288	1149	1957
ARMCHAIR NO ARMREST	50	0,71	1787	1546	1466	1386	1198	1092	1000	943	886	1460	1268	1077	962	1632
CHAISE LOUNGUE	75	1,64	2890	2557	2446	2335	2077	1929	1802	1723	1644	2436	2172	1908	1749	2673
CHAISE LOUNGUE MAX	80	1,99	3262	2887	2763	2638	2347	2181	2038	1949	1860	2751	2454	2157	1979	3018
POUF	30	0,33	1203	1060	1013	965	855	791	740	705	670	1017	901	786	717	1121
TERMINAL POUF	30	0,31	1161	1036	994	953	856	800	753	723	693	990	891	792	733	1080

Nei casi di versioni componibili, richiesti con rifinitura nel rivestimento scelto anziché con fodera come normalmente prodotta, verrà valutato un sovrapprezzo concordato con l'azienda. Si precisa che per esigenze di produzione ci potrebbero essere modifiche nei materiali, nei rivestimenti e nelle dimensioni del prodotto senza preavviso. I pesi ed i volumi riportati in scheda sono prettamente indicativi poiché suscettibili di tolleranze dettate dai processi produttivi. Nelle realizzazioni combinate in diversi rivestimenti, in presenza di categorie differenti, il prezzo da considerare è quello della categoria più alta.

In cases of modular versions, requested with finishing in the chosen upholstery instead of lining as normally produced, a surcharge agreed with the company will be considered. It should be noted that due to production requirements there may be changes in materials, upholstery and product dimensions without prior notice. The weights and volumes given in the sheet are purely indicative as they are susceptible to tolerances dictated by production processes. In combined realizations in different coatings, where there are different categories, the price to be considered is that of the highest category.



PREZZI ESEMPIO | PRICE EXAMPLE

MOD. TULIPANO EXPO FIERA

Versione | version: Poltrona Recliner | Armchair recliner

Rivestimento | Covering: NQ-7313 PREMIUM MAYA Carta da zucchero (Premium B)

Prezzo Listino | Price List: : PREMIUM B 2.715 EURO

*Cuscini accessori e poggiatesta esclusi | *Cushions and backrest cushions excluded



Salone del Mobile. Milano



DIMENSIONI Size

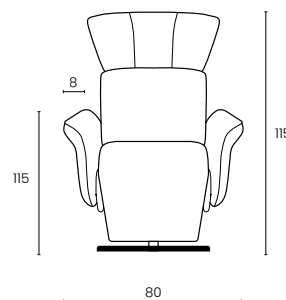
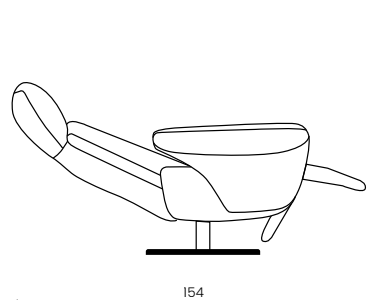

CARATTERISTICHE PRINCIPALI

- ✓ DOPPIO MOTORE
- ✓ RECLINER
- ✓ PRESA USB

MAIN FEATURES

- ✓ DUAL MOTOR
- ✓ RECLINER
- ✓ USB SOCKET



DATI TECNICI

Struttura: multistrato, abete, faggio
Poggiatesta: poliuretano densità 25kg/m³
Spalliera: poliuretano densità 30 kg/m³
Braccioli: poliuretano densità 28 kg/m³
Seduta: poliuretano densità 35 kg/m³
Piedi: acciaio lucido

TECHNICAL DATA

Frame: plywood, fir, beech
Headrest: polyurethane density 25 kg/m³
Backrest: polyurethane density 30 kg/m³
Armrests: polyurethane density 28 kg/m³
Seat: polyurethane density 35 kg/m³
Feet: shined steel

La tecnologia e il design sono i due concetti alla base di questo progetto. Le curve ergonomiche e l'imbottitura a varie densità conferiscono alla poltrona un comfort unico. Una base girevole conferisce libertà di movimento, sensazione amplificata dal recliner a due motori indipendenti. La presa usb è un accessorio ormai indispensabile.

Technology and design are the two concepts behind this project. Ergonomic curves and multi-density padding give the chair a unique comfort. A swivel base gives freedom of movement, a sensation amplified by the recliner with two independent motors. The usb socket is a now indispensable accessory.

LISTINO | PRICE LIST

TULIPANO	LEATHER								FABRIC			MODAMILANO				
VERSION	PESO	CBM	LUXURY	PREMIUM C	PREMIUM B	PREMIUM A	ROYAL B	ROYAL A	FABRIC C	FABRIC B	FABRIC A	MM D	MM C	MM B	MM A	GREEN
ARMCHAIR	60	0,74	3003	2787	2715	2643	2475	2379	2296	2245	2193	2708	2536	2365	2262	2863

Nei casi di versioni componibili, richiesti con rifinitura nel rivestimento scelto anziché con fodera come normalmente prodotto, verrà valutato un sovrapprezzo concordato con l'azienda. Si precisa che per esigenze di produzione ci potrebbero essere modifiche nei materiali, nei rivestimenti e nelle dimensioni del prodotto senza preavviso. I pesi ed i volumi riportati in scheda sono prettamente indicativi poiché suscettibili di tolleranze dettate dai processi produttivi. Nelle realizzazioni combinate in diversi rivestimenti, in presenza di categorie differenti, il prezzo da considerare è quello della categoria più alta.

In cases of modular versions, requested with finishing in the chosen upholstery instead of lining as normally produced, a surcharge agreed with the company will be considered. It should be noted that due to production requirements there may be changes in materials, upholstery and product dimensions without prior notice. The weights and volumes given in the sheet are purely indicative as they are susceptible to tolerances dictated by production processes. In combined realizations in different coatings, where there are different categories, the price to be considered is that of the highest category.



PREZZI ESEMPIO - PRICE EXAMPLE

MOD. BUBBLE EXPO FIERA

Versione - Version: Poltrona - Armchair

Rivestimento - Covering: NQ-BI-02 BALI Nero (Fabric B)

Prezzo Listino - price list: FABRIC B 1.982 EURO

*Cuscini accessori e poggiatesta esclusi - *Cushions and backrest cushions excluded

modamilano®
collection



DIMENSIONI Size

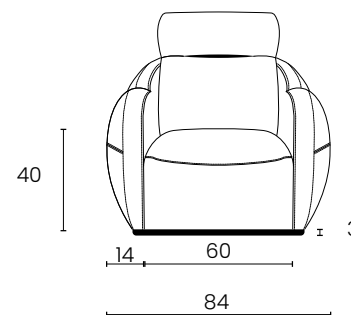
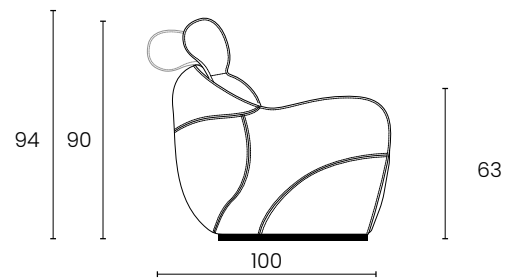

CARATTERISTICHE PRINCIPALI

- ✓ POGGIATESTA REGOLABILI
- ✓ BASE IN LEGNO
- ✓ SEDUTA SUPER COMFORT

MAIN FEATURES

- ✓ ADJUSTABLE HEADRESTS
- ✓ WOODEN BASE
- ✓ SUPER COMFORT SEAT



DATI TECNICI

Struttura: multistrato, abete, faggio
Poggiatesta: poliuretano densità 30 kg/m³
Spalliera: poliuretano densità 30 kg/m³
Braccioli: poliuretano densità 30 kg/m³
Seduta: poliuretano densità 35 kg/m³
Piedi: legno laccato

TECHNICAL DATA

Frame: plywood, fir, beech
Headrest: polyurethane density 30 kg/m³
Backrest: polyurethane density 30 kg/m³
Armrests: polyurethane density 30 kg/m³
Seat: polyurethane density 35 kg/m³
Feet: high-gloss wood

Bubble è un progetto che rappresenta un'emozione: la gioia. Il design si ispira alla felicità stimolata dalle linee curve e alla perfezione della sfera. Un senso di libertà e freschezza viene evocato dalle colorazioni pop del rivestimento.

Bubble is a design that represents an emotion: joy. The design is inspired by the happiness stimulated by the curved lines and perfection of the sphere. A sense of freedom and freshness is evoked by the pop colors of the upholstery.

LISTINO | PRICE LIST

BUBBLE	LEATHER								FABRIC			MODAMILANO				GREEN
VERSION	PESO	CBM	LUXURY	PREMIUM C	PREMIUM B	PREMIUM A	ROYAL B	ROYAL A	FABRIC C	FABRIC B	FABRIC A	MM D	MM C	MM B	MM A	GREEN
ARMCHAIR	44	0,8							2026	1982						2516

Nei casi di versioni componibili, richiesti con rifinitura nel rivestimento scelto anziché con fodera come normalmente prodotto, verrà valutato un sovrapprezzo concordato con l'azienda. Si precisa che per esigenze di produzione ci potrebbero essere modifiche nei materiali, nei rivestimenti e nelle dimensioni del prodotto senza preavviso. I pesi ed i volumi riportati in scheda sono prettamente indicativi poiché suscettibili di tolleranze dettate dai processi produttivi. Nelle realizzazioni combinate in diversi rivestimenti, in presenza di categorie differenti, il prezzo da considerare è quello della categoria più alta.

In cases of modular versions, requested with finishing in the chosen upholstery instead of lining as normally produced, a surcharge agreed with the company will be considered. It should be noted that due to production requirements there may be changes in materials, upholstery and product dimensions without prior notice. The weights and volumes given in the sheet are purely indicative as they are susceptible to tolerances dictated by production processes. In combined realizations in different coatings, where there are different categories, the price to be considered is that of the highest category.



PREZZI ESEMPIO - PRICE EXAMPLE

MOD. MITICA EXPO FIERA

Versione - version: Poltroncina - Armchair

Rivestimento - Covering: NQ-NL-6010 NILO EART (Premium C) + dettagli NQ-TR-67 TRILLY GLICINE (MM B)

Prezzo Listino - Price List: PREMIUM C 1.060 EURO

*Cuscini accessori e poggiatestai esclusi - *Cushions and backrest cushions excluded



Salone del Mobile. Milano



DIMENSIONI

Size

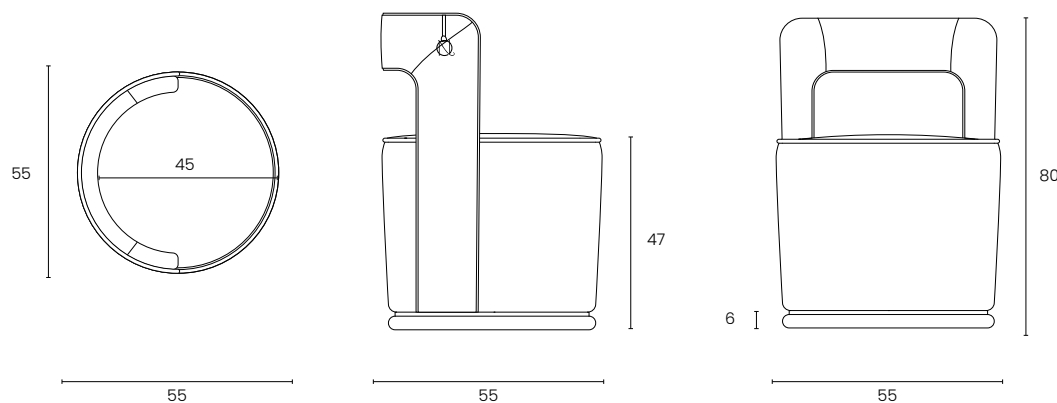

CARATTERISTICHE PRINCIPALI

✓ BASE GIREVOLE

MAIN FEATURES

✓ SWIVEL BASE



DATI TECNICI

Struttura: multistrato, abete, faggio
Poggiatesta: poliuretano densità 30 kg/m³
Spalliera: poliuretano densità 21 kg/m³
Seduta: poliuretano densità 35 kg/m³
Base girevole rivestita
Paracolpi

TECHNICAL DATA

Frame: plywood, fir, beech
Headrest: polyurethane density 30 kg/m³
Backrest: polyurethane density 30 kg/m³
Seat: polyurethane density 35 kg/m³
Swivel base upholstered
Paracolpi

La poltroncina Mitica è perfetta per qualsiasi ambiente. La base girevole ci permette un movimento naturale durante l'utilizzo che libera lo spirito e riposa la mente. Realizzabile in tantissime varianti di tessuto o pelle e innumerevoli colorazioni.

The Mitica armchair is perfect for any environment. The swivel base allows us natural movement during use that frees the spirit and rests the mind. It can be made in many variations of fabric or leather and countless colors.

LISTINO | PRICE LIST

MITICA	LEATHER								FABRIC			MODAMILANO				GREEN
VERSION	PESO	CBM	LUXURY	PREMIUM C	PREMIUM B	PREMIUM A	ROYAL B	ROYAL A	FABRIC C	FABRIC B	FABRIC A	MM D	MM C	MM B	MM A	GREEN
ARMCHAIR	19,2	0,24	1205	1060	1011	963	850	785	730	695	660	1007	875	776	706	1111

Base girevole in legno: verifica le finiture in gamma - *Wooden swivel base: check available wooden finishing (150 euro)*

Nei casi di versioni componibili, richiesti con rifinitura nel rivestimento scelto anziché con fodera come normalmente prodotto, verrà valutato un sovrapprezzo concordato con l'azienda. Si precisa che per esigenze di produzione ci potrebbero essere modifiche nei materiali, nei rivestimenti e nelle dimensioni del prodotto senza preavviso. I pesi ed i volumi riportati in scheda sono prettamente indicativi poiché suscettibili di tolleranze dettate dai processi produttivi. Nelle realizzazioni combinate in diversi rivestimenti, in presenza di categorie differenti, il prezzo da considerare è quello della categoria più alta.

In cases of modular versions, requested with finishing in the chosen upholstery instead of lining as normally produced, a surcharge agreed with the company will be considered. It should be noted that due to production requirements there may be changes in materials, upholstery and product dimensions without prior notice. The weights and volumes given in the sheet are purely indicative as they are susceptible to tolerances dictated by production processes. In combined realizations in different coatings, where there are different categories, the price to be considered is that of the highest category.



PREZZI ESEMPIO - PRICE EXAMPLE

MOD. MARICLA EXPO FIERA

Versione - versione: Poltroncina - Armchair

Rivestimento - Covering: NQ-4017 PREMIUM NATURAL Cognac (Premium A) + NQ-MN-09 MONET VERDE (MM C)

Prezzo Listino - Price List: PREMIUM A 1.351 EURO

*Cuscini accessori e poggiatesta esclusi - *Cushions and backrest cushions excluded



Salone del Mobile. Milano



DIMENSIONI

Size

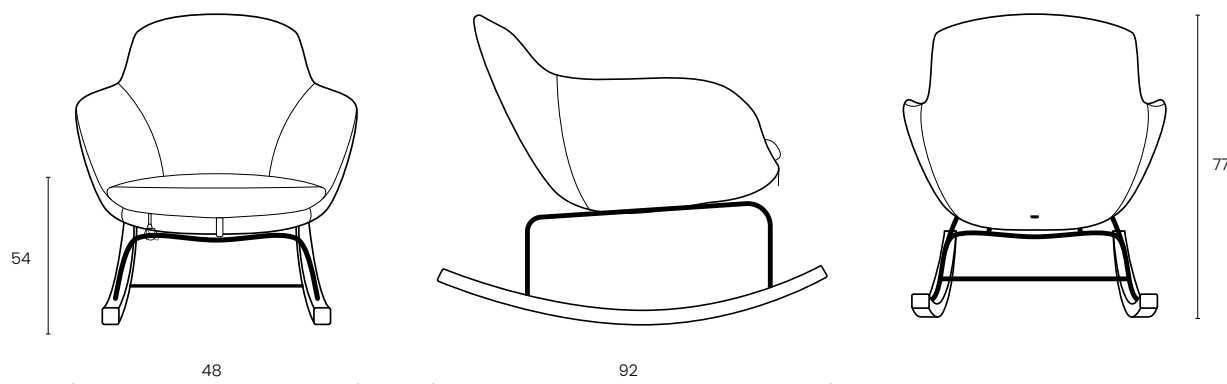

CARATTERISTICHE PRINCIPALI

- ✓ SEDUTA A DONDOLO
- ✓ BASE IN LEGNO E METALLO

MAIN FEATURES

- ✓ ROCKING SEAT
- ✓ WOODEN AND METAL BASE



DATI TECNICI

Struttura: multistrato, abete, faggio

Spalliera e seduta:

poliuretano densità 30 kg/m³

Struttura base acciaio lucida + legno:

verifica le finiture in gamma

Struttura base canna di fucile + legno:

verifica le finiture in gamma

TECHNICAL DATA

Frame: plywood, fir, beech

Backrest e seat:

polyurethane density 30 kg/m³

Shined steel base structure + wooden:

check available wooden finishing

Gun metal base structure + wooden:

check available wooden finishing

La poltrona a dondolo by NicolaQuinto rivestita con i materiali esclusivi della collezione modamilano. Una piacevole esperienza di comfort, lasciarsi cullare dal movimento naturale della poltrona eleva la sensazione di relax.

The rocking armchair by NicolaQuinto upholstered with exclusive materials from the modamilano collection. A pleasant experience of comfort, being rocked by the natural movement of the armchair elevates the feeling of relaxation.

LISTINO | PRICE LIST

MARICLA	LEATHER								FABRIC			MODAMILANO				
VERSION	PESO	CBM	LUXURY	PREMIUM C	PREMIUM B	PREMIUM A	ROYAL B	ROYAL A	FABRIC C	FABRIC B	FABRIC A	MM D	MM C	MM B	MM A	GREEN
CUDDLECHAIR	30	0,5	1484	1404	1377	1351	1288	1253	1225	1205	1185	1383	1317	1251	1212	1443

Nei casi di versioni componibili, richiesti con rifinitura nel rivestimento scelto anziché con fodera come normalmente prodotto, verrà valutato un sovrapprezzo concordato con l'azienda. Si precisa che per esigenze di produzione ci potrebbero essere modifiche nei materiali, nei rivestimenti e nelle dimensioni del prodotto senza preavviso. I pesi ed i volumi riportati in scheda sono prettamente indicativi poiché suscettibili di tolleranze dettate dai processi produttivi. Nelle realizzazioni combinate in diversi rivestimenti, in presenza di categorie differenti, il prezzo da considerare è quello della categoria più alta.

In cases of modular versions, requested with finishing in the chosen upholstery instead of lining as normally produced, a surcharge agreed with the company will be considered. It should be noted that due to production requirements there may be changes in materials, upholstery and product dimensions without prior notice. The weights and volumes given in the sheet are purely indicative as they are susceptible to tolerances dictated by production processes. In combined realizations in different coatings, where there are different categories, the price to be considered is that of the highest category.



PREZZI ESEMPIO | PRICE EXAMPLE

MOD. BILL EXPO FIERA

Versione | version: nr 3 Poltrone Max + Angolo + Chaise Loungue Max | nr 3 Armchair Max + Angle + Chaise Loungue Max

Rivestimento | Covering: NAIROBI (Fabric B)

Prezzo Listino | Price List: FABRIC B 565

*Cuscini accessori e poggiatesta esclusi | *Cushions and backrest cushions excluded



Salone del Mobile. Milano



DIMENSIONI

size

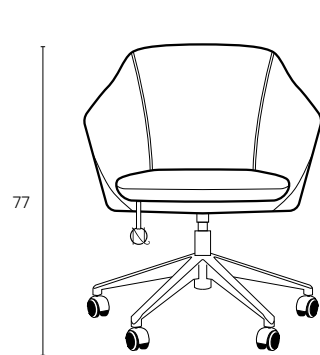

77

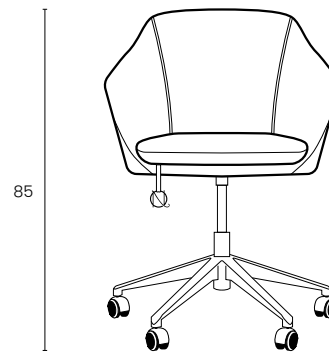

85

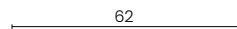

62

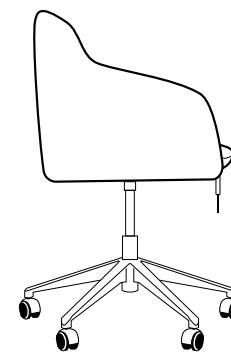

60



DATI TECNICI

Struttura: multistrato, abete, faggio, acciaio
Spalliera: poliuretano schiumato a freddo
Seduta: poliuretano schiumato a freddo
Piedi: acciaio lucido, nero opaco

TECHNICAL DATA

Frame: plywood, fir, beech, steel
Backrest: cold-foamed polyurethane
Seat: cold-foamed polyurethane
Feet: shined steel, black matte

Bill è una poltroncina con base girevole in acciaio dotata di ruote. La seduta dalle dimensioni ridotte è pratica ed ergonomica. Un prodotto della linea contract, perfetto per uffici, sale riunioni, sale d'attesa o per living dal taglio stilistico industrial.

Bill is a small armchair with a steel swivel base equipped with casters. The small-sized seat is practical and ergonomic. A product from the contract line, perfect for offices, meeting rooms, waiting rooms or living rooms with an industrial stylistic cut.

LISTINO | PRICE LIST

BILL	LEATHER								FABRIC			MODAMILANO				
VERSION	PESO	CBM	LUXURY	PREMIUM C	PREMIUM B	PREMIUM A	ROYAL B	ROYAL A	FABRIC C	FABRIC B	FABRIC A	MM D	MM C	MM B	MM A	GREEN
CUDDLECHAIR	11,5	0,29	783	721	700	680	631	603	580	565	550	698	649	599	570	743

Nei casi di versioni componibili, richiesti con rifinitura nel rivestimento scelto anziché con fodera come normalmente prodotto, verrà valutato un sovrapprezzo concordato con l'azienda. Si precisa che per esigenze di produzione ci potrebbero essere modifiche nei materiali, nei rivestimenti e nelle dimensioni del prodotto senza preavviso. I pesi ed i volumi riportati in scheda sono prettamente indicativi poiché suscettibili di tolleranze dettate dai processi produttivi. Nelle realizzazioni combinate in diversi rivestimenti, in presenza di categorie differenti, il prezzo da considerare è quello della categoria più alta.

In cases of modular versions, requested with finishing in the chosen upholstery instead of lining as normally produced, a surcharge agreed with the company will be considered. It should be noted that due to production requirements there may be changes in materials, upholstery and product dimensions without prior notice. The weights and volumes given in the sheet are purely indicative as they are susceptible to tolerances dictated by production processes. In combined realizations in different coatings, where there are different categories, the price to be considered is that of the highest category.



PREZZI ESEMPIO | PRICE EXAMPLE

MOD. CORSICA EXPO FIERA

Versione | version: Pouf

Rivestimento | Covering: NQ-BF-73 BALI Fucsia (Fabric B)

Prezzo Listino | Price List: : FABRIC B 452 EURO

*Cuscini accessori e poggiatestai esclusi | *Cushions and backrest cushions excluded



Salone del Mobile. Milano



Divertente, incredibilmente utile e facilmente ambientabile. Corsica è un pouf dalle curve morbide perfetto per qualsiasi ambiente.

Fun, incredibly useful and easily set. Corsica is a softly curved pouf perfect for any setting.

DIMENSIONI

Size

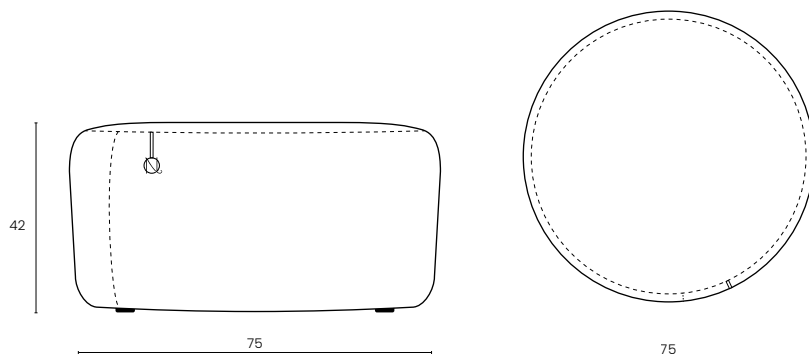

DATI TECNICI

Struttura: multistrato, abete, faggio
Seduta: poliuretano densità 35 kg/m³
Piedi: PCV

TECHNICAL DATA

Frame: plywood, fir, beech
Seat: polyurethane density 35 kg/m³
Feet: PVC

LISTINO | PRICE LIST

CORSICA	VERSION	PESO	CBM	FABRIC		
				FABRIC C	FABRIC B	GREEN
POUF		12	0,24	469	452	654

Nei casi di versioni componibili, richiesti con rifinitura nel rivestimento scelto anziché con fodera come normalmente prodotto, verrà valutato un sovrapprezzo concordato con l'azienda. Si precisa che per esigenze di produzione ci potrebbero essere modifiche nei materiali, nei rivestimenti e nelle dimensioni del prodotto senza preavviso. I pesi ed i volumi riportati in scheda sono prettamente indicativi poiché suscettibili di tolleranze dettate dai processi produttivi. Nelle realizzazioni combinate in diversi rivestimenti, in presenza di categorie differenti, il prezzo da considerare è quello della categoria più alta.

In cases of modular versions, requested with finishing in the chosen upholstery instead of lining as normally produced, a surcharge agreed with the company will be considered. It should be noted that due to production requirements there may be changes in materials, upholstery and product dimensions without prior notice. The weights and volumes given in the sheet are purely indicative as they are susceptible to tolerances dictated by production processes. In combined realizations in different coatings, where there are different categories, the price to be considered is that of the highest category.